

## 1) Inner Box Drawing

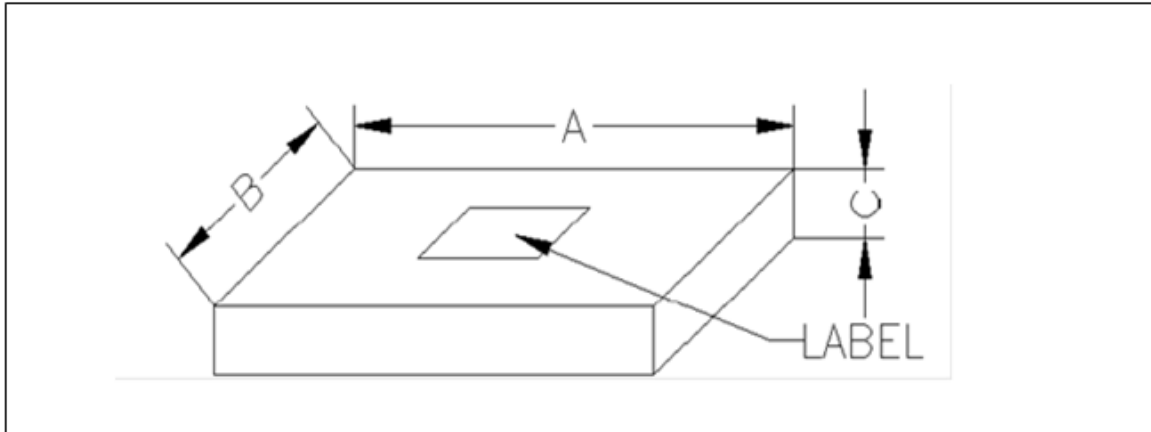

## 2) Inner Box Label

**TYPE:** XXXXXXXX

**P/N:** XXXXXXXXXXXX-XXXX-XXXX---Yangjie Internal Control Part No.

**Exp.** XXXXXX -XX-XXXXX

**P/O:** XXXXXXXXXXXX----Purchase Order No by Distributor

**Exp.** CDR1106300050

Means this is the 50<sup>th</sup> orders on June. 30 2011 in Yangjie system.

**Q'TY (PCS):** XXXX---Qty of Inner Box

**LOT NO.:** XXXXXXXX---Yangjie Internal Tracking No.

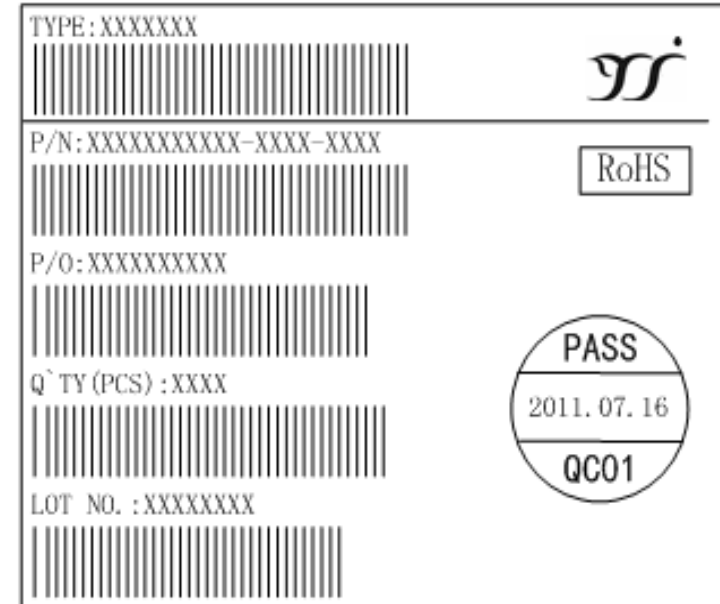

### 3) Outer Carton Drawing

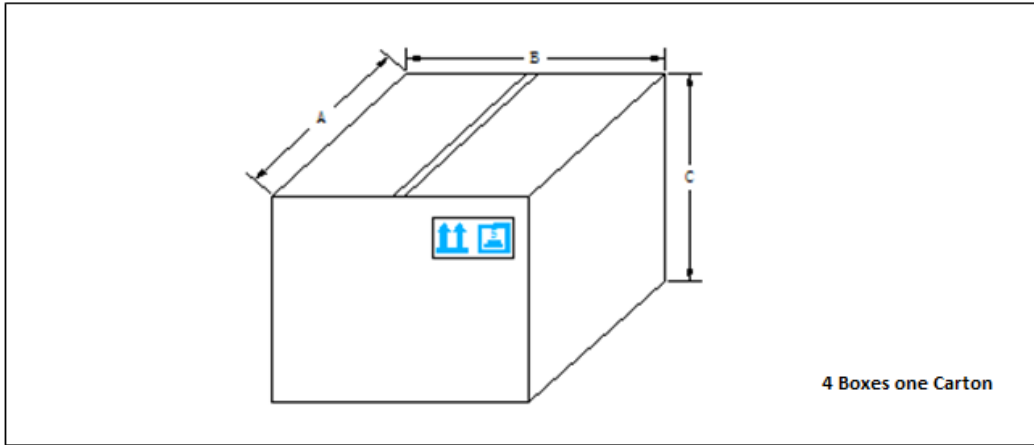

### 4) Outer Carton Label

**TYPE:** XXXXXXXX

**P/N:** XXXXXXXXXXXX-XXXX-XXXX---Yangjie Internal Control Part No.

**Exp.** XXXXXX -XX-XXXXX

**P/O:** XXXXXXXXXXXX----Purchase Order No by Distributor.

**Q'TY (PCS):** XXXX---Qty of Outer Carton

**LOT NO.:** XXXXXXXX---Yangjie Internal Tracking No.

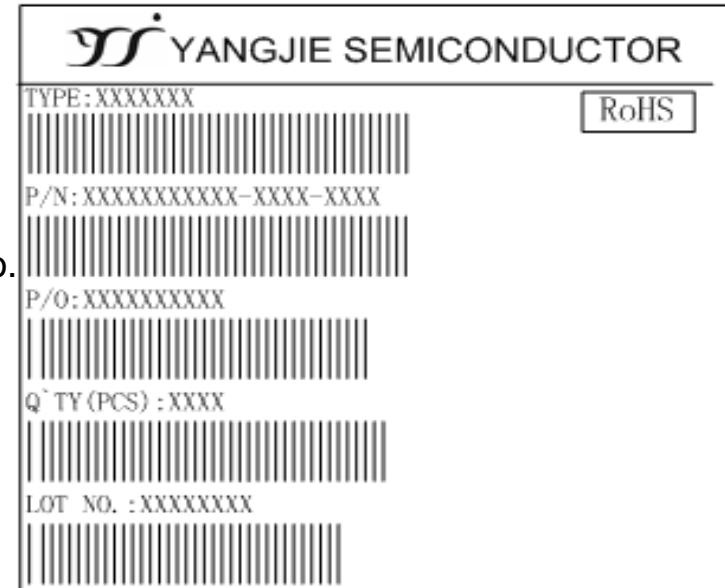

### 1) Tube Drawing and Size

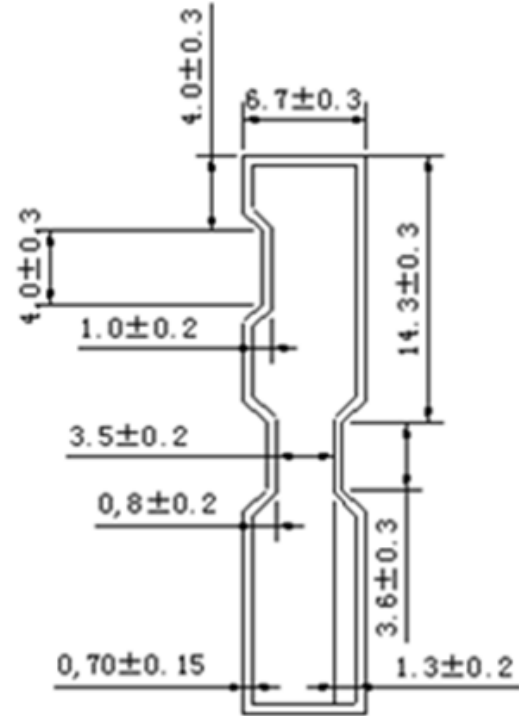
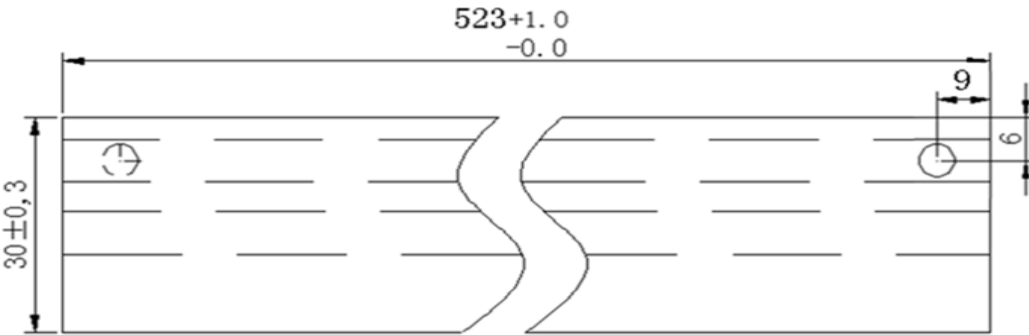

Notes: Unmarked Tolerance:  $\pm 0.25$

Tube Thickness:  $0.5 \pm 0.1$

Unit: mm

## 2) Inner Box

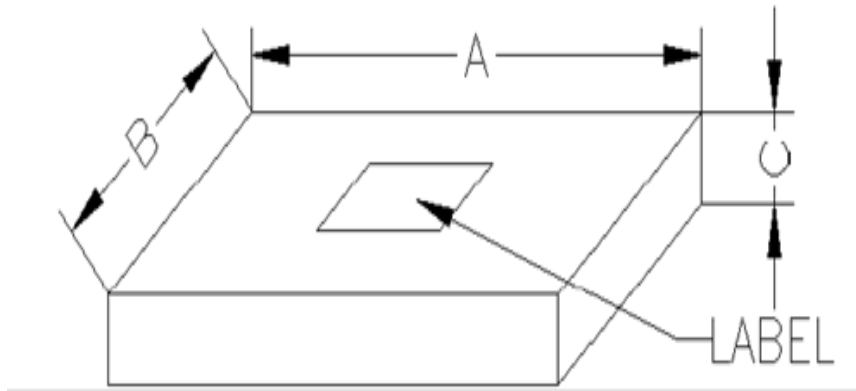

## 3) Inner Box Label

**TYPE:** XXXXXX

**P/N:** XXXXXXXXXXXX-XXXX-XXXX---Yangjie Internal Control Part No.

**Exp.** XXXXXX -XX-XXXX







**P/O:** XXXXXXXXXXXX----Purchase Order No by Distributor

**Exp.** CA1106300050

Means this is the 50<sup>th</sup> orders on June. 30 2011 in Yangjie system.

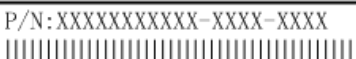
**Q'TY (PCS):** XXXX---Qty of Inner Box

**LOT NO.:** XXXXXXXX---Yangjie Internal Tracking No.

TYPE: XXXXXX	
	
P/N: XXXXXXXXXXXX-XXXX-XXXX	
	
P/O: XXXXXXXXXXXX	
	
Q`TY (PCS) : XXXX	
	
LOT NO. : XXXXXXXX	
	

### 4 ) Outer Carton Drawing

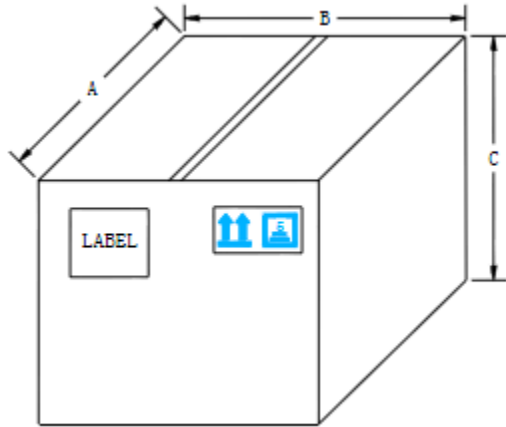

### 5) Outer Carton Label

**TYPE:** XXXXXX

**P/N:** XXXXXXXXXXXX-XXXX-XXXX---Yangjie Internal Control Part No.

**Exp.** XXXXXX -XX-XXXX







**P/O:** XXXXXXXXXXXX----Purchase Order No by Distributor

**Exp.** CA1106300050

Means this is the 50<sup>th</sup> orders on June. 30 2011 in Yangjie system.

**Q'TY (PCS):** XXXX---Qty of Outer Carton

**LOT NO.:** XXXXXXXX---Yangjie Internal Tracking No.

 YANGJIE SEMICONDUCTOR	
TYPE: XXXXXX	RoHS
	
P/N: XXXXXXXXXXXX-XXXX-XXXX	
	
P/O: XXXXXXXXXXXX	
	
Q'TY (PCS) : XXXX	
	
LOT NO. : XXXXXXXX	
	

## 1) Tape Drawing and Size

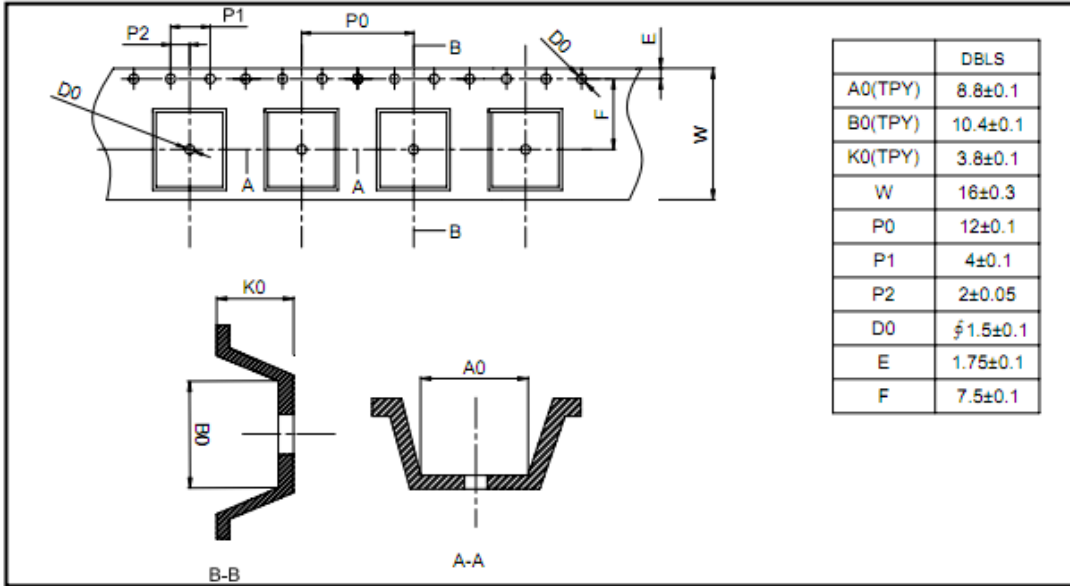

## 2) Reel Drawing and Size

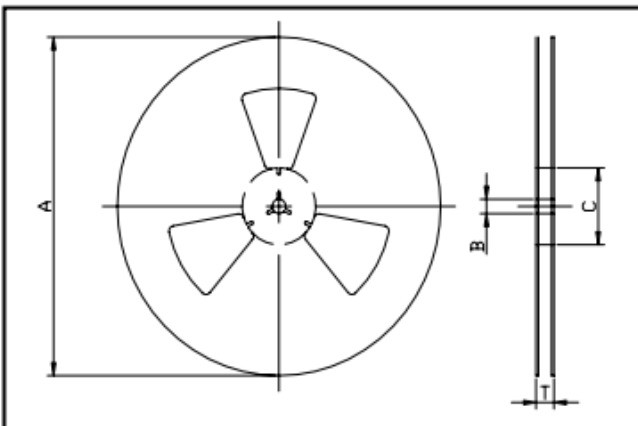

Tape Size	Product Type	A MAX	B ±0.5	C MIN	T MAX
13"	DBS	330 (13.0)	14 (0.551)	100 (3.94)	20 (0.79)

### 3) Inner Box Drawing

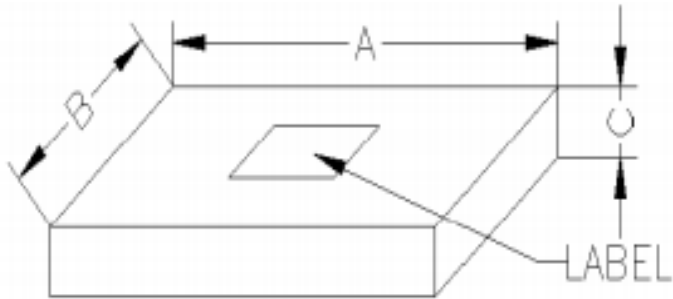

### 4) Inner Box Label

**TYPE:**XXXXXX

**Code:** XXXX-Date Code

**Exp.** 05H07

**Q'TY (PCS):** XXXX---Qty of Inner Box

**Exp.** 3000

**LOT NO.:** XXXXXXXX---Yangjie Internal Tracking No. in ERP.

**Exp.** 10080110016

10 means the product voltage profile;

0801 means the date of process card B;

100 means the card serial no;16 means the staff number.

<b>TYPE: DB157S</b>	
<hr/>	
<b>CODE:05H07</b>	<b>RoHS</b>
<b>Q'TY(PCS): 3000</b>	
<b>LOT NO:10080110016</b>	

## 1) Tape Drawing and Size

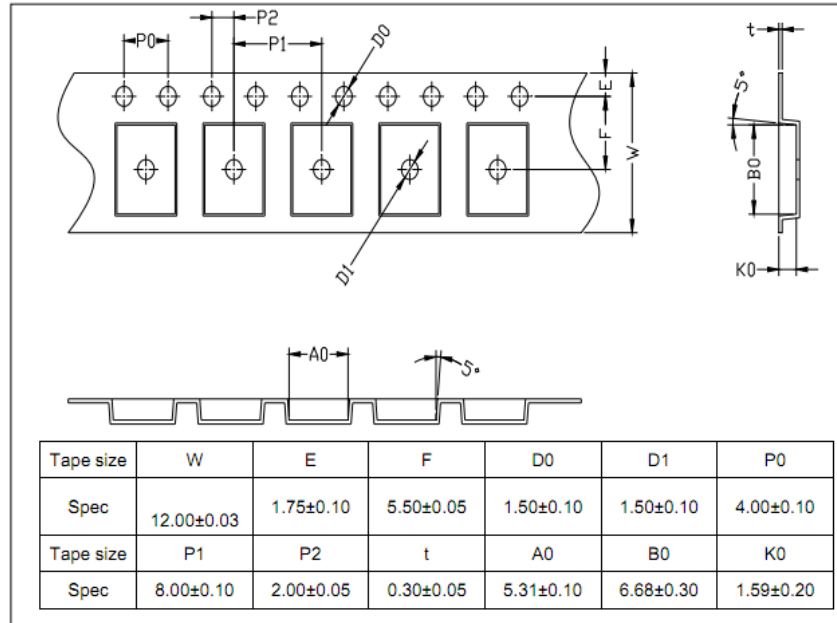

## 2) Reel Drawing and Size

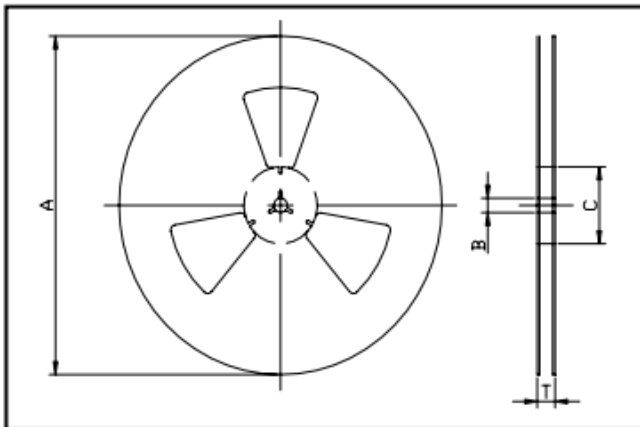

Tape size	Product type	A ±1	B ±0.5	C +1/-0.5	T ±0.5
13"	ABS	330 (13.0)	14 (0.551)	75 (2.952)	18.4 (0.724)



# ABS

YANGZHOU YANGJIE ELECTRONIC TECHNOLOGY CO.,LTD.

## 3) Reel Label

**TYPE:**XXXXXX





**P/N:** XXXXXXXXXXX-XXXX-XXXX

Yangjie Internal Control Part No.

**P/O:** XXXXXXXXXXX----Purchase Order No by Distributor.

**Q'TY (PCS):** XXXX---Qty of Reel

**LOT NO.:** XXXXXXXX---Yangjie Internal Tracking No. .

TYPE: XXXXXXXX 	
P/N: XXXXXXXXXXX-XXXX-XXXX 	<b>RoHS</b>
P/O: XXXXXXXXX 	 <p>PASS 2011. 07. 16 QC01</p>
Q'TY (PCS) : XXXX 	
LOT NO. : XXXXXXXX 	

## 4) Inner Box Drawing

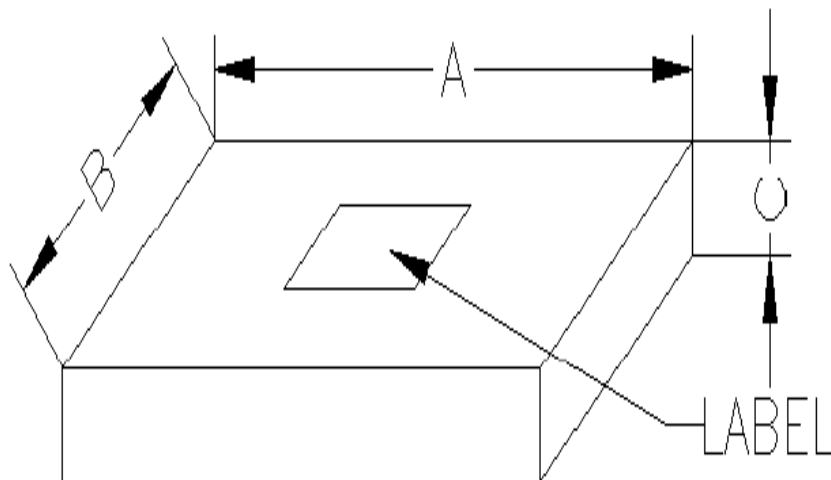

## 5) Outer Carton Drawing

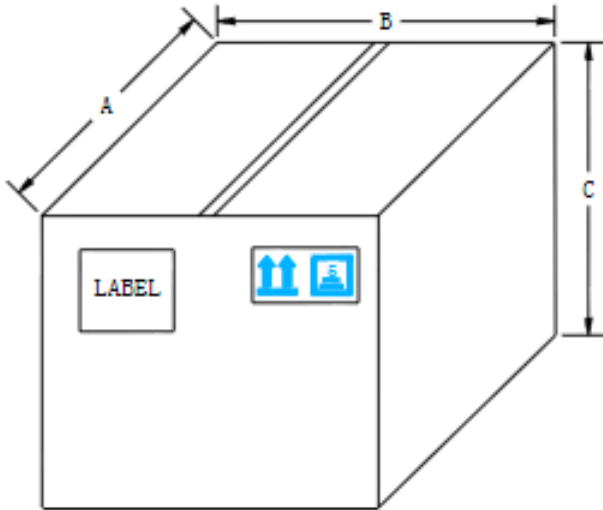

## 6) Outer Carton Label

**TYPE:**XXXXXX







**P/N:** XXXXXXXXXXX-XXXX-XXXX

Yangjie Internal Control Part No.

**P/O:** XXXXXXXXXXX----Purchase Order No by Distributor

**Q'TY (PCS):** XXXX---Q'ty of Outer Carton

**LOT NO.:** XXXXXXXX---Yangjie Internal Tracking No.

 <b>YANGJIE SEMICONDUCTOR</b>	
TYPE: XXXXXXXX	RoHS
	
P/N: XXXXXXXXXXX-XXXX-XXXX	
	
P/O: XXXXXXXXXXX	
	
Q'TY (PCS) : XXXX	
	
LOT NO. : XXXXXXXX	
	

## 1) Tape Drawing and Size

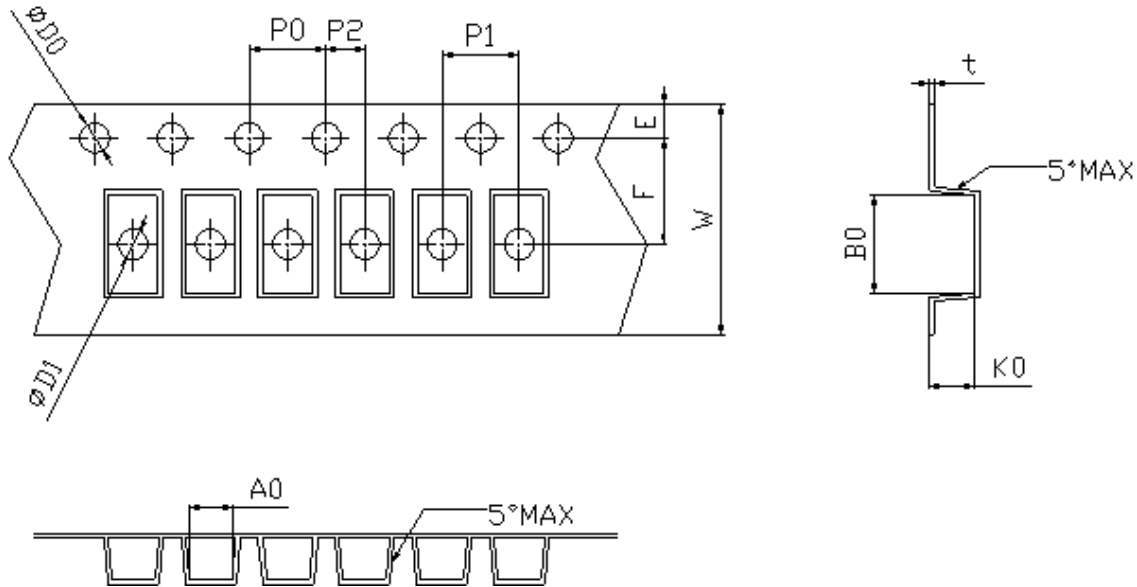

Symbol	W	E	F	D0	D1	P0
Spec	12.0±0.1 5	1.75±0.1 0	5.50±0.0 5	1.55±0.0 5	1.55±0.0 5	4.00±0.1 0
Symbol	P1	P2	t	A0	B0	K0
Spec	4.00±0.1 0	2.00±0.0 5	0.24±0.0 5	2.79±0.1 0	5.33±0.1 0	2.36±0.0 5

Unit: mm

## 2) Reel Drawing and Size

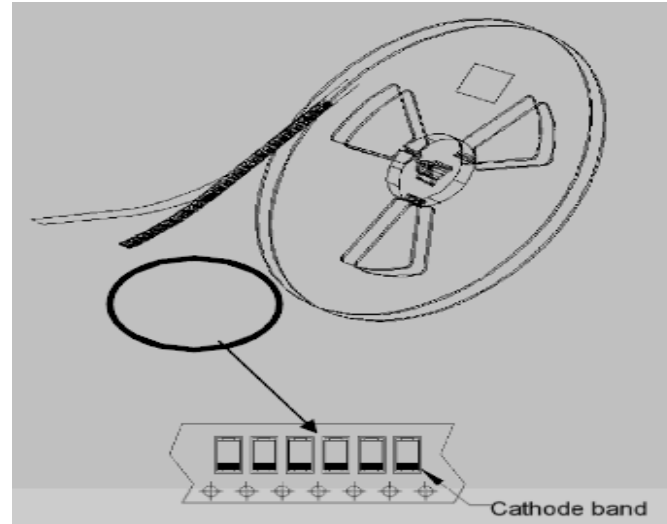
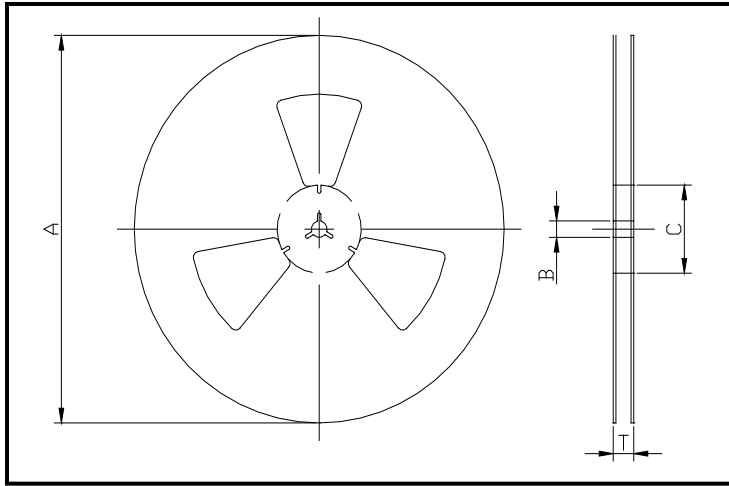

Reel size	Product type	A ±1	B ±0.5	C +1/-0.5	T ±0.5
13"	SMA	330 (13.0)	14 (0.551)	75 (2.952)	18.4 (0.724)

## 3) Reel Label

**TYPE:**XXXXXX









**P/N:** XXXXXXXXXXX-XXXX-XXXX

Yangjie Internal Control Part No.

**P/O:** XXXXXXXXXXX----Purchase Order No by Distributor

**Q'TY (PCS):** XXXX---Qty of Reel

**LOT NO.:** XXXXXXXX---Yangjie Internal Tracking No.

TYPE: XXXXXXX	
	
P/N: XXXXXXXXXXX-XXXX-XXXX	
	
P/O: XXXXXXXXXXX	
	
Q`TY (PCS) : XXXX	
	
LOT NO. : XXXXXXX	
	

## 4) Inner Box Drawing

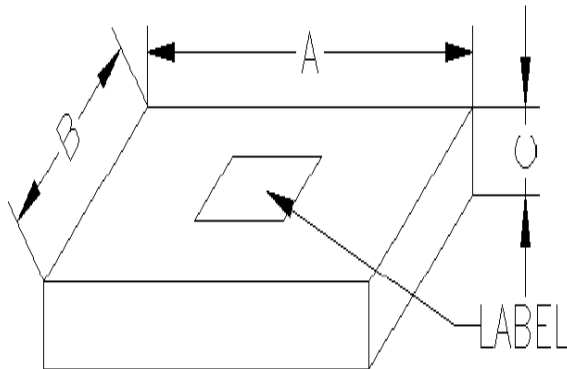

## 5 ) Outer Carton Drawing

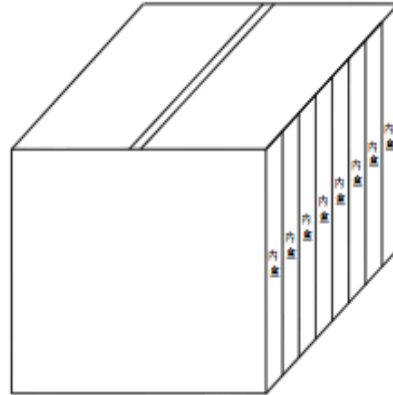
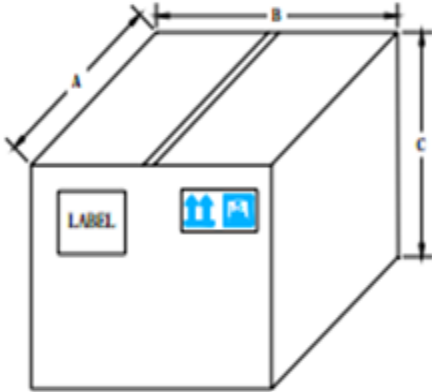

## 6 ) Outer Carton Label

**TYPE:**XXXXXX







**P/N:** XXXXXXXXXXX-XXXX-XXXX

Yangjie Internal Control Part No.

**P/O:** XXXXXXXXXXX----Purchase Order No by Distributor

**Q'TY (PCS):** XXXX---Qty of Outer Carton

**LOT NO.:** XXXXXXXX---Yangjie Internal Tracking No.

 YANGJIE SEMICONDUCTOR	
TYPE: XXXXXXXX	RoHS
	
P/N: XXXXXXXXXXX-XXXX-XXXX	
	
P/O: XXXXXXXXXXX	
	
Q'TY (PCS) : XXXX	
	
LOT NO. : XXXXXXXX	
	

# 6KBJ



扬杰科技  
YANGJIE TECHNOLOGY

YANGZHOU YANGJIE ELECTRONIC TECHNOLOGY CO.,LTD.

## 1) Tube Drawing and Size

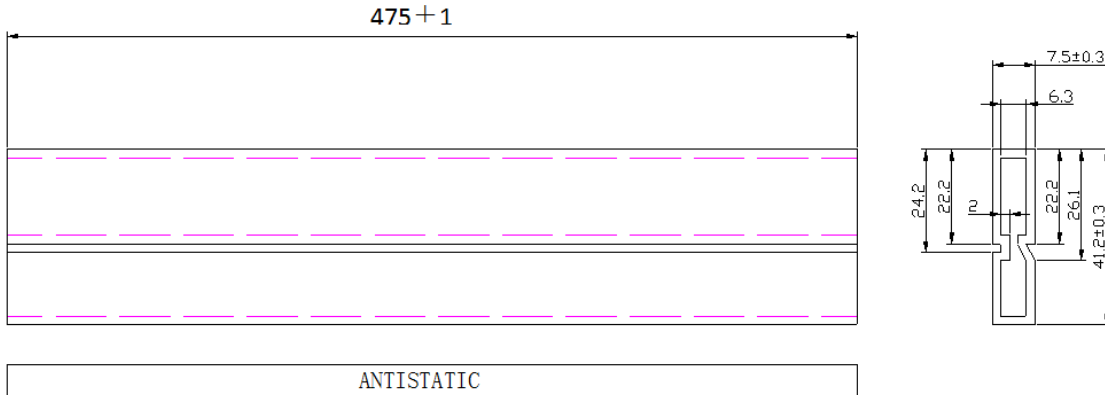

Notes: Unmarked Tolerance:  $\pm 0.25$

Tube Thickness:  $0.5 \pm 0.1$

Unit: mm



## 2) Inner Box

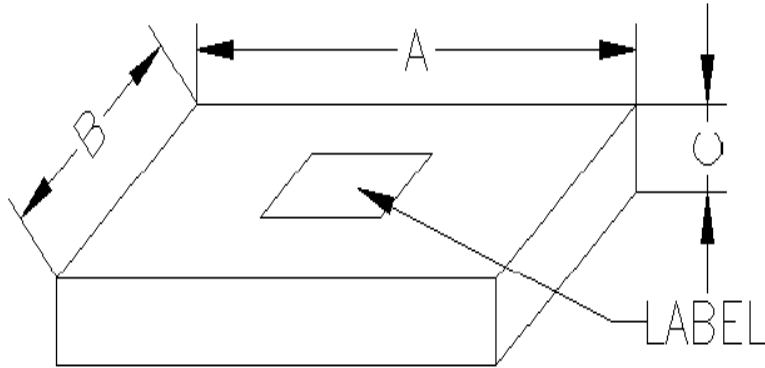

## 3) Inner Box Label

**TYPE:** XXXXX









**P/N:** XXXXXXXXXXX-XXXX-XXXX

Yangjie Internal Control Part No.

**P/O:** XXXXXXXXXXX----Purchase Order No by Distributor

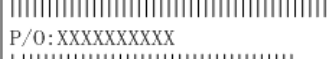
**Q`TY (PCS):** XXXX---Qty of Inner Box

**LOT NO.:** XXXXXXXX---Yangjie Internal Tracking No.

TYPE: XXXXXX	
	
P/N: XXXXXXXXXXX-XXXX-XXXX	
	
P/O: XXXXXXXXXXX	
	
Q`TY (PCS) : XXXX	
	
LOT NO. : XXXXXXXX	
	



## 4) Outer Carton Drawing

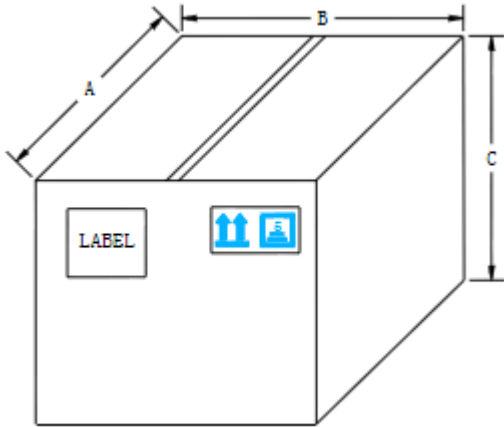

## 5) Outer Carton Label

**TYPE:** XXXXX

**P/N:** XXXXXXXXXXX-XXXX-XXXX

Yangjie Internal Control Part No.

**P/O:** XXXXXXXXXXX----Purchase Order No by Distributor

**Q'TY (PCS):** XXXX---Qty of Outer Box

**LOT NO.:** XXXXXXXX---Yangjie Internal Tracking No.

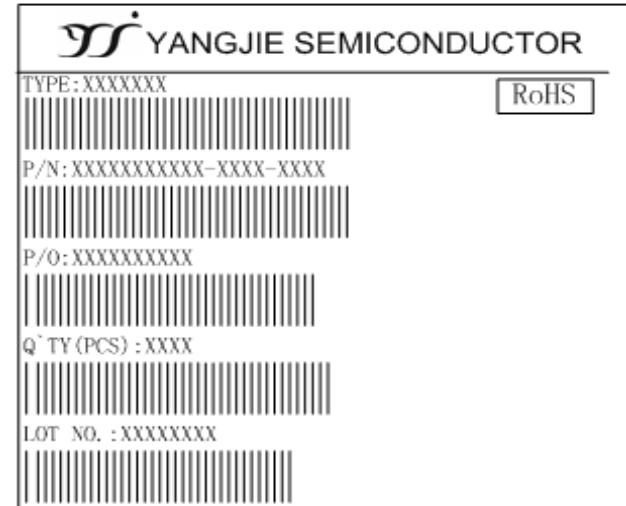

## 1) Inner Box Drawing

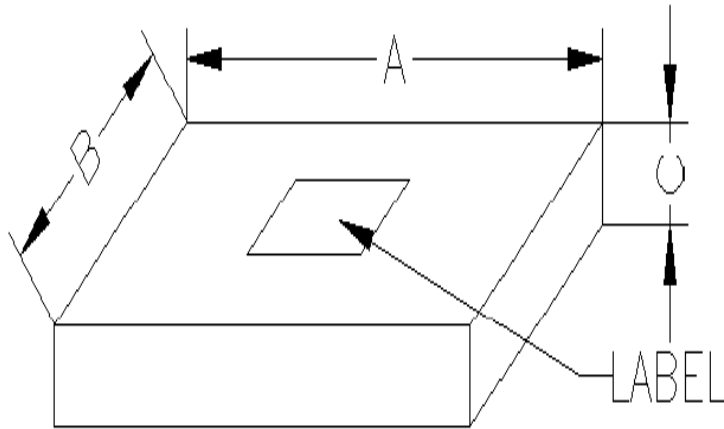

## 2) Inner Box Label

**TYPE:** XXXXX





**P/N:** XXXXXXXXXXXX-XXXX-XXXX

Yangjie Internal Control Part No.

**P/O:** XXXXXXXXXXXX----Purchase Order No by Distributor

**Q'TY (PCS):** XXXX---Qty of Inner Box

**LOT NO.:** XXXXXXXX---Yangjie Internal Tracking No.

 <b>YANGJIE SEMICONDUCTOR</b>	
TYPE: XXXXXX	RoHS
	
P/N: XXXXXXXXXXXX-XXXX-XXXX	
	
Q`TY (PCS) : XXXX	
	
LOT NO. : XXXXXXXXXXXX	
	

### 3) Outer Carton Drawing

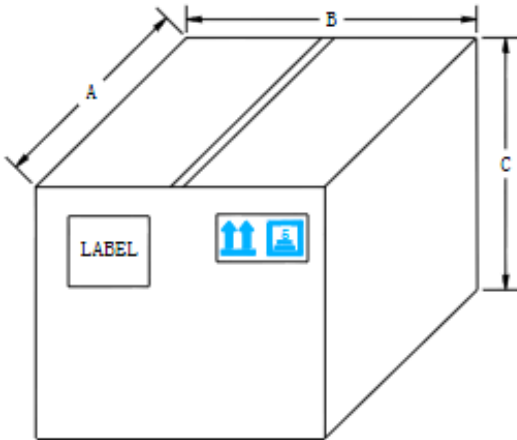

### 4) Outer Carton Label

**TYPE:** XXXXX

**P/N:** XXXXXXXXXXX-XXXX-XXXX

Yangjie Internal Control Part No.

**P/O:** XXXXXXXXXXX----Purchase Order No by Distributor

**Q'TY (PCS):** XXXX---Qty of Outer Box

**LOT NO.:** XXXXXXXX---Yangjie Internal Tracking No.

